

# 14 PINS 1.0 Pitch SMD Horizontal Type Top Contact

Ver	Date	Description
1.0	July-26-2012	Preliminary Release

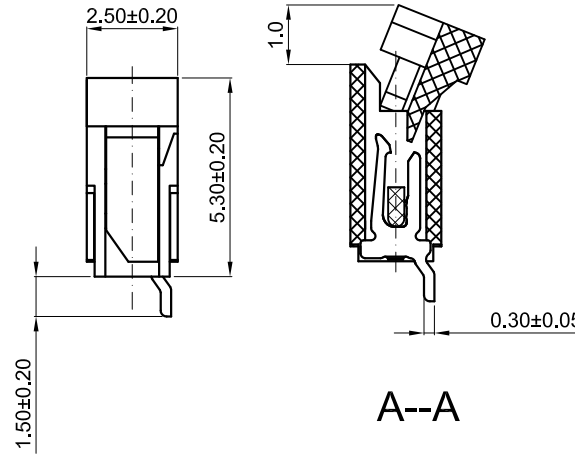
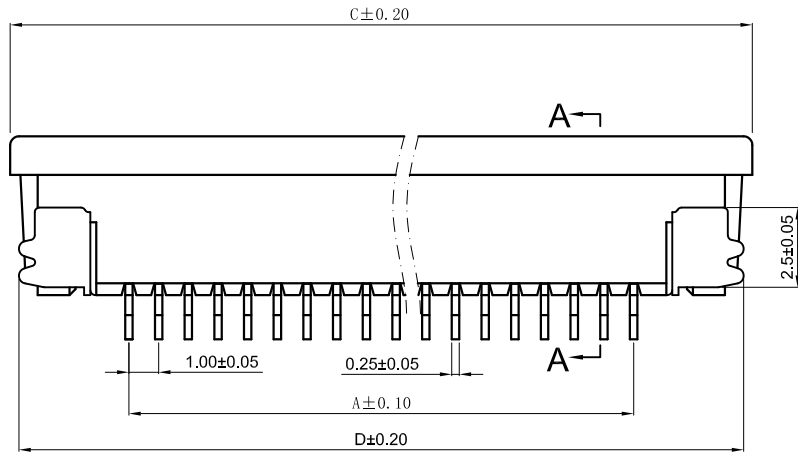

Pin Num	A	B	C	D
14	13.0	15.3	21.1	20.1

### Material:

- 1、Housing: NYlon46 UL94V-0 Grey;
- 2、Loeker: PPS UL94V-0;
- 3、Contact: Phosphor bronze, tin/lead-plated;
- 4、Solder tab: Phosphor bronze, tin/lead-plated.

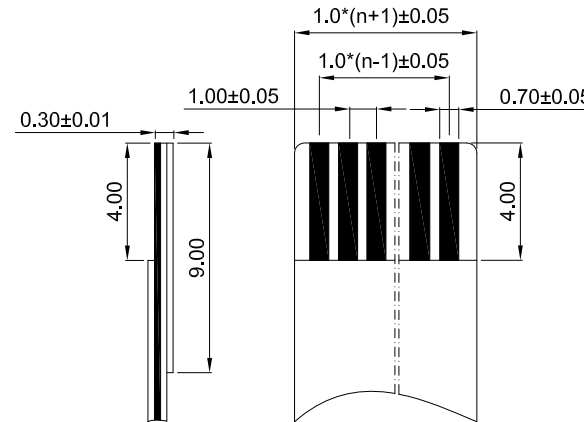
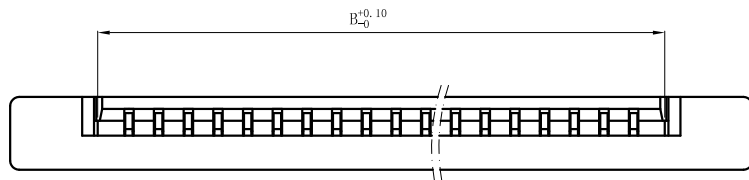

### Specification:

- 2、Unverified Tolerance should comply with SJ1372-79;
- 3、Temperature Range: -25°C~85°C;
- 4、Rated Voltage: 50V, AC, DC;
- 5、Contact Resistance:  $\leq 0.03 \Omega$ ;
- 6、Insulation Resistance:  $\geq 500M \Omega$ ;
- 7、Withstand Voltage: 500V, AC/minute.

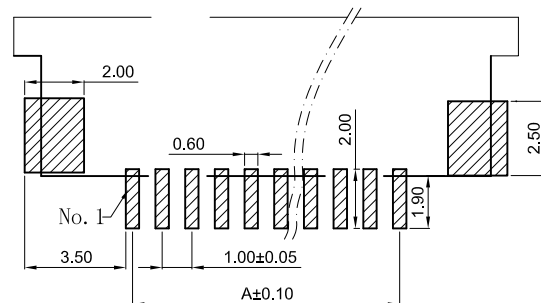

 <b>旭日东方科技有限公司</b> <b>EastRising Technology Co., Ltd.</b> <small>www.lcd-china.com TEL: +86-755-33503873 FAX: +86-755-33507642-801</small>		<b>CD</b>
	UNIT: MM	SIZE: A4
	SHEET: 1 OF 1	
Part Number for Order: <b>ER-CON14HT-2</b>		
DRAWN BY : Jim	CHECKED BY: Tony	APPROVED BY : Liu